







# BPOWER AGM-L16

The BCL series batteries are made in the AGM technology, designed for heavy cyclic work. Thanks the use of special carbon additives BCL series batteries have greater load accepting and require less time charging. They are characterized by efficiency and reliability and have a very long cyclic life of 700 cycles at a discharge depth of up to 80%.

BASIC PARAMETERS		OPERATING TEMPERATURE RANGE	
Nominal Voltage	6V	Storage Temperature Range	-15°C ~ 40°C
Nominal Capacity	400Ah	Charge Temperature Range	0°C ~ 40°C
Technology	VRLA AGM	Discharge Temperature Range	- 20°C ~ 55°C
Container Material	ABS UL94 HB		
PHYSICAL PARAMETERS		CHARGING CURRENT	
Dimensions (L x W x H)	295 x 180 x 428 (mm)	Recommended	40A
Weight	54,20kg		
Terminal	DT	Maximum	80A
Cell layout	0		
RATED CAPACITY (25°C)		CHARGING VOLTAGE (25°C)	
400 Ah	20hr	Cyclic work	7,35V - 7,45V
375 Ah	10hr		
342 Ah	5hr		

- 
**Cycle life**  
 Long cycle life (700 cycles at 80% DOD). Strong recovery ability of deep discharge.
- 
**Tight construction**  
 Reliable sealing structure ensures no leakage during use.
- 
**Carbon additives**  
 The addition of carbon ensures faster charging, protection against sulfation and less electrolyte stratification. Thanks to the addition of carbon sulfates dissolve faster.
- 
**Separator**  
 High quality AGM separator: Extend cycle life and prevent micro short circuit
- 
**High performance**  
 High energy, low internal resistance, low self-discharge, no noise, easy to operate.
- 
**Corrosion resistance**  
 A special alloy improves the resistance of the plate against corrosion, increases service life and good deep discharge performance.

**Headquarters in Warsaw**  
 Jana Kazimierza 61  
 01-267 Warszawa

**Branch in Gdansk**  
 Twarda 12  
 80-871 Gdańsk

+48 22 877 54 96  
 biuro@baterie.com.pl  
 www.baterie.com.pl

**BP BATERIE**  
 PRZEMYSŁOWE

## Terminals

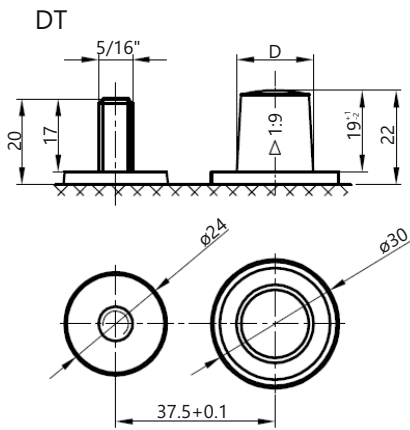

Terminal Torque Values in-lb(Nm):17.69-26.53(2.0-3.0)

## Cycle life

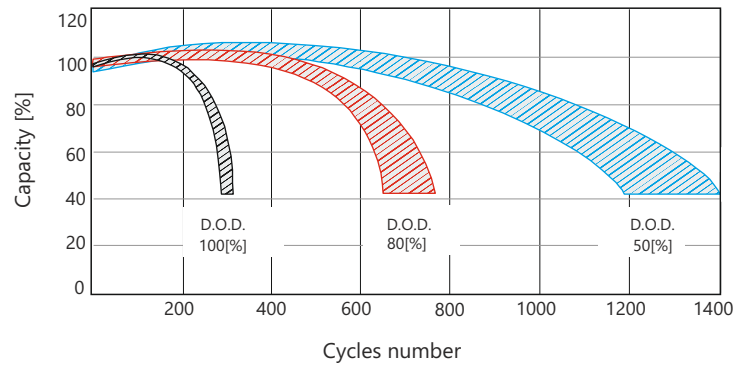

## Dimensions

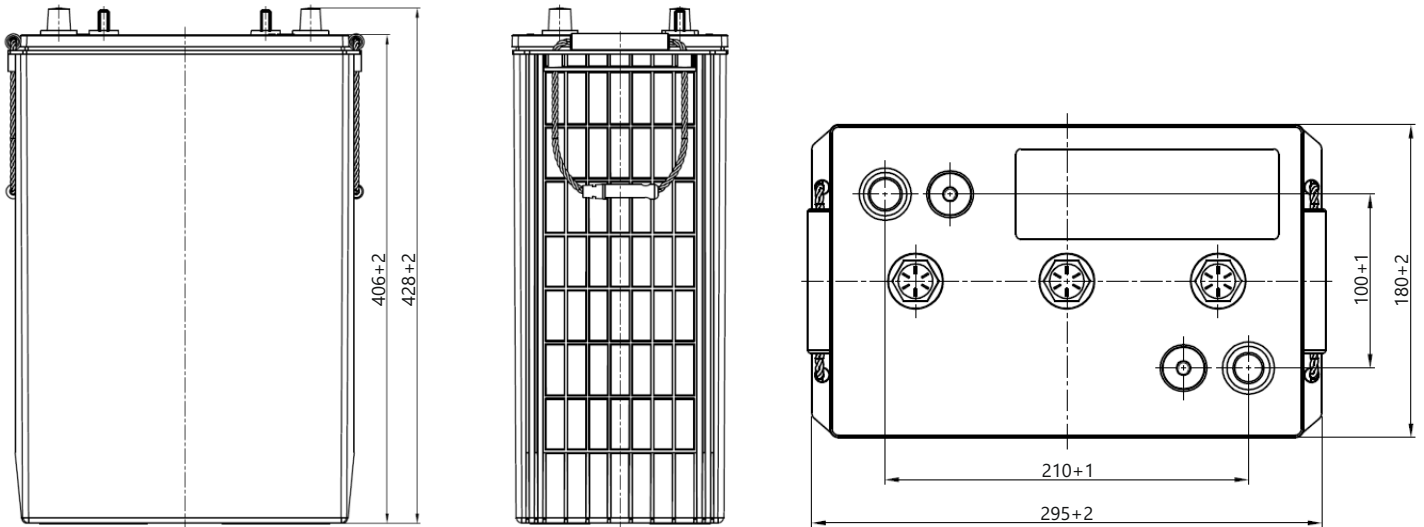

## Environment information

Exploited batteries are considered as hazardous waste. These wastes due to their origin, chemical composition (they contains heavy metals like lead and other toxic substations) and other features may be dangerous for environment and human or animal health life. According to the waste act, waste in the form of batteries and accumulators should be collected separately from other types of waste.

In order to obtain more detailed information, we encourage you to contact us, we provide any information on how to handle with waste batteries and accumulators..

## Safety



## Recycling



**Headquarters in Warsaw**  
Jana Kazimierza 61  
01-267 Warszawa

**Branch in Gdansk**  
Twarda 12  
80-871 Gdańsk

+48 22 877 54 96  
biuro@baterie.com.pl  
www.baterie.com.pl

**BP BATERIE**  
PRZEMYSŁOWE